

DBPOWER

User Manual

Portable Car Jump Starter

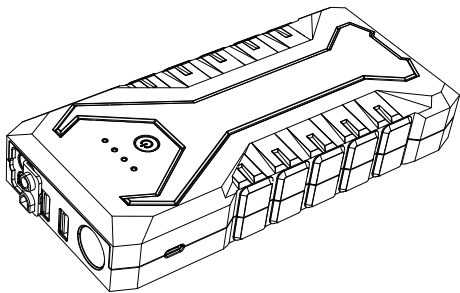

2000A 19200mAh

For petrol engines below 8L and diesel engines below 6.5L

ACTIVATE YOUR 12 MONTH WARRANTY & EXCLUSIVE GIFT

Register within 2 weeks after receiving your new product.

PLEASE VISIT NOW

→ www.dbpower.co/warranty

CUSTOMER SERVICE

✉ support@dbpower.co **f** @DBPOWER.CO









NOTE

1. DO NOT start any engines that exceed the maximum displacement the jump starter can bear.
2. DO NOT crank the engine for more than 3 seconds.
3. Allow the jump starter to cool down for at least 1 minute between each start attempt.
4. Please ensure the device is at least 50% charged before use.

Attention

1. **This device applies to petrol engines up to 8L and diesel engines up to 6.5L.** Please don't start a vehicle with a higher engine capacity or it will cause serious damage to the device and could be dangerous to the user.
2. **Don't crank the engine for more than 3 seconds.** Allow the jump starter to cool down for at least 1 minute after each start.
3. Your jump starter will work best when it is fully charged. If less than 30% charged, it will not be able to start your engine.
4. Clear the dust on the electrodes of your car battery before jump starting.
5. **If the instructions are followed correctly but your vehicle doesn't start instantly, please wait for 5-10 minutes and try again.** But please don't make repeated attempts to jump start the engine without allowing time for the device to cool down.
6. Do not connect the positive and negative polarity together when it's power on.
7. Separate the cables from the jump starter when they are not being used.
8. It is prohibited to charge the device immediately after a jump start. Please wait at least 30 minutes if you want to charge the device after a jump start.
9. To preserve lifespan, recharge the device at least once every 3 months.
10. Use original or certified cables.
11. Do not expose the jump starter to liquids. Do not disassemble.
12. Avoid dropping the device and exposing it to extreme temperatures.

Specifications

	Capacity	19200mAh/ 71.04Wh
	Weight	615g/ 21.7oz
	Size	191 x 87 x 36mm/ 7.5 x 3.4 x 1.4inch
	In(Out)	Type-C 5V/3A
	Output 1	Smart 5V/9V/12V
	Output 2	5V/2.1A
	Jumping Peak Output Current	2000A
	Jumping Start Output Current	1000A
	Operation Temperature Range	-20°C- 60°C/ -4°F- 140°F

Package



1 x Jump Starter

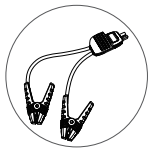

1 x Intelligent Jumper Clamps

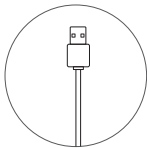

1 x Type-C USB Line

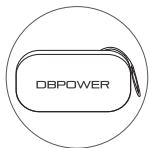

1 x Semi-Hard Case



1 x User Manual

At a Glance

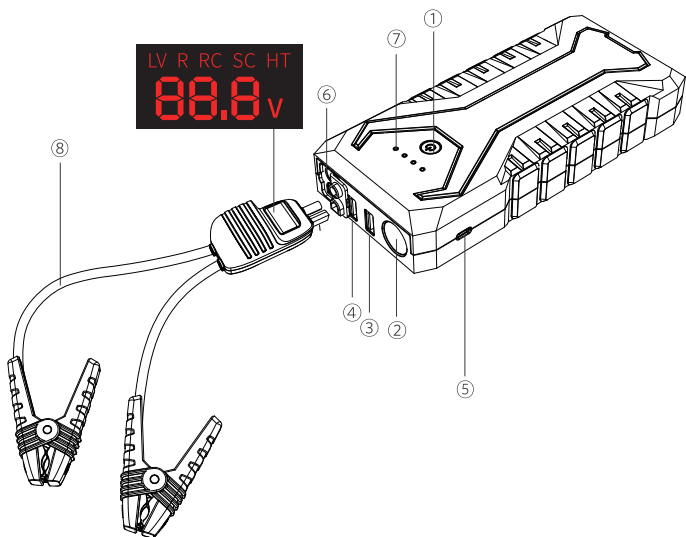

1. ON/ OFF Button & Function Key
2. LED Flashlight
3. Smart 5V/9V/12V USB Output
4. 5V/2.1A USB Output
5. Type-C 5V/3A Input/Output
6. Jumping Port
7. LED Power Meter
8. Jumper Cables

How to Jump Start Your Car

1. Turn on your jump starter and make sure it's over 30% charged. (Please charge it fully at the first time use.)

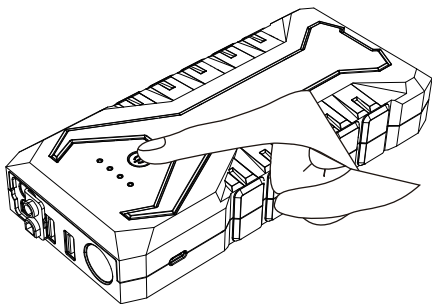

2. Insert jumper cables into jumping port. The digital tube frame will be lit up circularly from left to right.

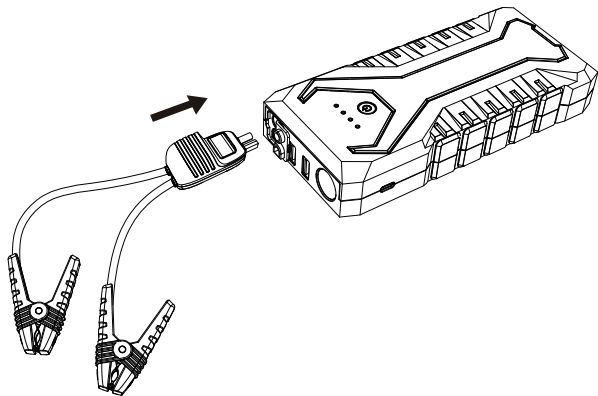

3. Connect the red clamp to the positive(+) terminal and the black clamp to the negative(-) terminal of the car battery. The screen on the clamps will show the jump starter's current voltage (The normal value is between 14V and 16.8V). And the device enter stand-by status (Please note that the clamps will detect the load every five seconds and give a warning tone. The device might not work if you start the engine at the moment of the warning tone. In addition, the clamps will disconnect automatically after 20 seconds and the "--" symbol will flash on the screen. Please remove and reconnect the clamps if you need to jump start after 20 seconds).

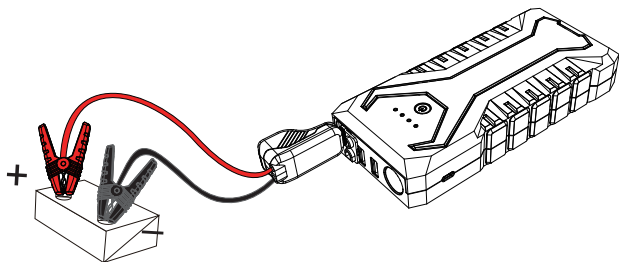

4. Start your engine.

5. Remove clamps and pack away.

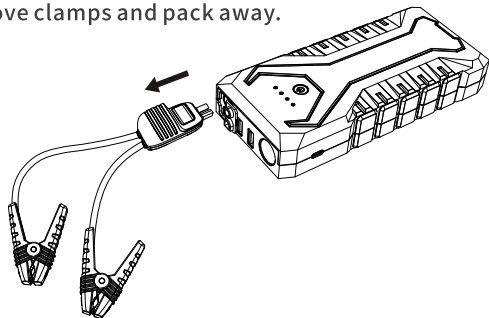

How to Charge Cellphones or Tablets

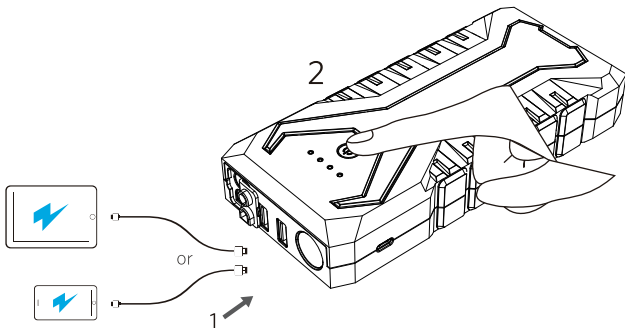

How to Use the LED Flashlight

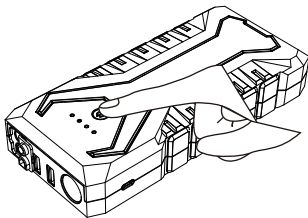

1. Hold to turn on / off.

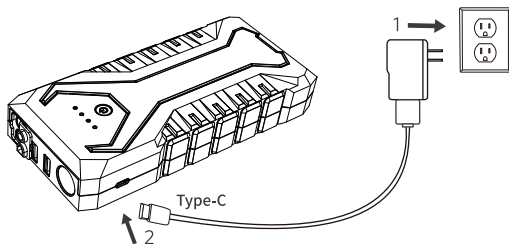

2. Press to toggle flash modes. Quick press once to change LED flash modes (high, strobe, SOS).

How to Recharge The Device



Adapter	5V/1A	5V/2A	5V/3A
Charging time  → 	≤14.5h	≤9.0h	≤6.0h

Note:

- 1. The charging adapter is not included. Please use a 5V universal adapter to charge the jump starter.**
- 2. We don't recommend charging the jump starter via a PC as it will take longer to charge than with an adapter.**

Exception Description Indicated by The Clamps

- LOW VOLTAGE

The characters 'LV' are lit up on the screen and the buzzer goes off once a second. The screen will show a voltage lower than 14V.

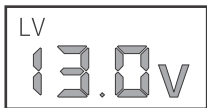

- HIGH VOLTAGE

The characters '888' are lit up on the screen and the buzzer goes off for a while.

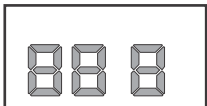

- REVERSE CHARGE

The characters "RC" are lit up on the screen. The symbol "--" flashes and the buzzer goes off once a second.

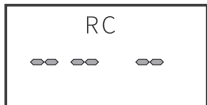

- REVERSE POLARITY

The character "R" is lit up on the screen. The "--" symbol flashes and the buzzer goes off once a second.

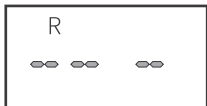

- HIGH TEMPERATURE

The characters "HT" are lit up on the screen. The "--" symbol flashes and the buzzer goes off once a second. It can restore automatically when temperature drops.

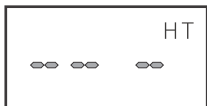

- EXCESS CONNECTION TIME

After the clamps are connected well for 20 sec, it will disconnect automatically and the "--" symbol flashes.

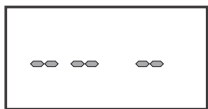

- OVERLOAD

The clamps will automatically disconnect when the jump starter's voltage is detected lower than 12V/3S, 9.0V/1S and 6.0V/0.1S during operation. The "--" symbol flashes. When the voltage returns to normal, disconnect the clamps and the protection will be removed automatically.



- SHORT CIRCUIT

The characters "SC" are lit up on the screen. The "--" symbol flashes and the buzzer goes off once a second.

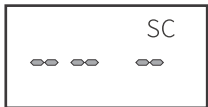

- BATTERY VOLTAGE TEST

When the clamps only connect to the car battery (not connect to the jump starter), the characters "RC" are lit up on the screen and the current battery voltage will be displayed at the same time.

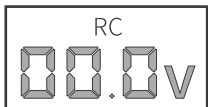

DBPOWER



3-year limited warranty



Lifetime technical support



support@dbpower.co



1-855-666-9888 (24 hours Mon-Fri)



www.dbpower.co



Made in China